



## Features

- Built-in active PFC function
- High efficiency up to 96%
- Fanless design, cooling by free air convection
- Aluminum case and filling with heat-conducted glue
- Withstand 10G vibration test
- -40 ~ +70°C wide operating range
- Charger for lead-acid batteries (flooded, Gel and AGM) and Li-ion batteries (lithium iron and lithium manganese)
- Built-in default 2/3 stage charging curves and programmable curve
- Built-in PMBus protocol / Optional CANBus protocol
- Output voltage and constant current level programmable
- Protections: Short circuit / Overload / Over voltage / Over temperature
- Built-in remote ON-OFF control
- DC OK active signal
- LED indicator for power on
- Optional wiring type with IP67 rating
- 6 years warranty

## Certificates

- Safety: UL/EN62368-1
- EMC: EN 55032 / 55024

## Applications

- Industrial automation machinery
- Industrial control system
- Mechanical and electrical equipment
- Electronic instruments, equipments or apparatus
- Household appliances

## Description

HEP-1000 is a 1000W industrial AC/DC power supply featuring the outstanding capability to operate under highly humid, dusty, oily, and high-vibration harsh environment. The entire series is housed with the aluminum case and fully potted with heat-conducted silicone. Adopting the full range 90~305VAC input, the entire series provides an output voltage line of 24V, 48V and 100V. In addition to the high efficiency up to 96%, that the whole series operates from -40°C ~ 70°C under air convection without fan. HEP-1000 has the complete protection functions and 10G anti-vibration capability; It is complied with the international safety regulations such as TUV EN62368-1 UL62368-1, and the design refers to EN61558-1 and EN60335-1. HEP-1000 series serves as a high performance power supply solution for various industrial applications.

## Model Encoding

HEP - 1000 - 24

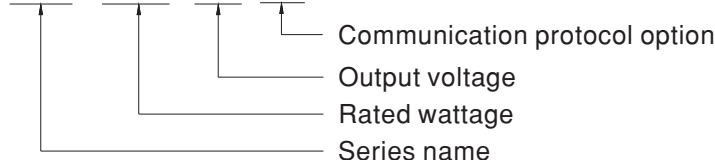

Type	Communication Protocol	Note
Blank	PMBus protocol	In Stock
CAN	CANBus protocol	By request

**SPECIFICATION FOR POWER SUPPLY**

MODEL		HEP-1000-24	HEP-1000-48	HEP-1000-100	
OUTPUT	DC VOLTAGE	24V	48V	100V	
	RATED CURRENT	42A	21A	10A	
	RATED POWER	1008W	1008W	1000W	
	RIPPLE & NOISE (max.) Note.2	200mVp-p	250mVp-p	500mVp-p	
	VOLTAGE ADJ. RANGE	By built-in potentiometer, SVR			
		24 ~ 30V	48 ~ 60V	100 ~ 125V	
	VOLTAGE TOLERANCE Note.3	±1.0%	±1.0%	±1.0%	
	LINE REGULATION	±0.5%	±0.5%	±0.5%	
	LOAD REGULATION	±0.5%	±0.5%	±0.5%	
SETUP, RISE TIME	1800ms, 80ms at full load 230VAC /115VAC				
HOLD UP TIME (Typ.)	16ms / 230VAC at 75% load 12ms / 230VAC at full load				
INPUT	VOLTAGE RANGE Note.4	90 ~ 305VAC 250 ~ 431VDC			
	FREQUENCY RANGE	47 ~ 63Hz			
	POWER FACTOR (Typ.)	PF>0.99/115VAC, PF>0.95/230VAC, PF>0.93/277VAC at full load			
	EFFICIENCY (Typ.)	95%	96%	96%	
	AC CURRENT (Typ.)	10.1A / 115VAC	5.3A / 230VAC	4.5A / 277VAC	
	INRUSH CURRENT(Typ.)	Cold start 40A at 230VAC			
LEAKAGE CURRENT	<0.75mA / 240VAC				
PROTECTION	OVERLOAD	105~125% rated output power Protection type : Constant current limiting, unit will shutdown after 5 sec, re-power on to recover.			
	SHORT CIRCUIT	Constant current limiting, unit will shutdown after 5 sec, re-power on to recover.			
	OVER VOLTAGE	30 ~ 35V	60 ~ 70V	125 ~ 145V	
		Protection type : Shut down O/P voltage, re-power on to recover			
OVER TEMPERATURE	Protection type : Shut down O/P voltage, recovers automatically after temperature goes down				
FUNCTION	OUTPUT VOLTAGE PROGRAMMABLE(PV) Note.5	Adjustment of output voltage is allowable to 50 ~ 125% of nominal output voltage Please refer to the Function Manual.			
	OUTPUT CURRENT PROGRAMMABLE(PC) Note.5	Adjustment of constant current level is allowable to 20 ~ 100% of rated current. Please refer to the Function Manual.			
	REMOTE ON/OFF CONTROL	Power ON : Short circuit Power OFF : Open circuit			
	AUXILIARY POWER	12V @ 0.5A tolerance ±10%, ripple=150mVp-p			
	DC-OK SIGNAL	The TTL signal out, PSU turn on = 4.4 ~ 5.5V ; PSU turn off = -0.5 ~ 0.5V. Please refer to the Function Manual.			
ENVIRONMENT	WORKING TEMP.	-40 ~ +70°C (Refer to "Derating Curve")			
	WORKING HUMIDITY	20 ~ 95% RH non-condensing			
	STORAGE TEMP., HUMIDITY	-40 ~ +80°C, 10 ~ 95% RH non-condensing			
	TEMP. COEFFICIENT	±0.03%/°C (0 ~ 50°C)			
	VIBRATION	20 ~ 500Hz, 10G 12min./1cycle, period for 72min. each along X, Y, Z axes			
SAFETY & EMC (Note.6)	SAFETY STANDARDS	UL62368-1, TUV EN62368-1, EAC TP TC 004 approved; design refer to EN61558-1, EN60335-1(by request)			
	WITHSTAND VOLTAGE	I/P-O/P:3KVAC I/P-FG:2KVAC O/P-FG:1.25KVAC			
	ISOLATION RESISTANCE	I/P-O/P, I/P-FG, O/P-FG:100M Ohms/500VDC/25°C / 70%RH			
	EMC EMISSION	Parameter	Standard	Test Level / Note	
		Conducted	EN55032 (CISPR32)	Class B	
		Radiated	EN55032 (CISPR32)	Class B	
		Harmonic Current	EN61000-3-2	Class A	
	Voltage Flicker	EN61000-3-3	-----		
	EMC IMMUNITY	EN55024, EN61000-6-2			
		Parameter	Standard	Test Level / Note	
		ESD	EN61000-4-2	Level 3, 8KV air ; Level 2, 4KV contact	
		Radiated	EN61000-4-3	Level 3	
		EFT / Burst	EN61000-4-4	Level 3	
		Surge	EN61000-6-2	2KV/Line-Line 4KV/Line-Earth	
Conducted		EN61000-4-6	Level 3		
Magnetic Field		EN61000-4-8	Level 4		
Voltage Dips and Interruptions	EN61000-4-11	>95% dip 0.5 periods, 30% dip 25 periods, >95% interruptions 250 periods			
OTHERS	MTBF	197.9K hrs min. Telcordia SR-332 (Bellcore) ; 52.32K hrs min. MIL-HDBK-217F (25°C)			
	DIMENSION	310*144*48.5mm (L*W*H)			
	PACKING	4Kg;4pcs/17Kg/1.04CUFT			
NOTE	1. All parameters NOT specially mentioned are measured at 230VAC input, rated load and 25°C of ambient temperature. 2. Ripple & noise are measured at 20MHz of bandwidth by using a 12" twisted pair-wire terminated with a 0.1uf & 47uf parallel capacitor. 3. Tolerance :includes set up tolerance, line regulation and load regulation. 4. Derating may be needed under low input voltages. Please check the derating curve for more details. 5. PV/PC functions when users do not use SVR. 6. The power supply is considered a component which will be installed into a final equipment. All the EMC tests are been executed by mounting the unit on a 720mm*360mm metal plate with 1mm of thickness. The final equipment must be re-confirmed that it still meets EMC directives. For guidance on how to perform these EMC tests, please refer to "EMI testing of component power supplies." (as available on http://www.meanwell.com) 7. The ambient temperature derating of 3.5°C/1000m with fanless models and of 5°C/1000m with fan models for operating altitude higher than 2000m(6500ft). ※ Product Liability Disclaimer : For detailed information, please refer to https://www.meanwell.com/serviceDisclaimer.aspx				



**SPECIFICATION FOR CHARGER**

MODEL		HEP-1000-24	HEP-1000-48	HEP-1000-100	
OUTPUT	BOOST CHARGE VOLTAGE V <sub>boost</sub>	28.8V	57.6V	115.2V	
	FLOAT CHARGE VOLTAGE V <sub>float</sub>	27.6V	55.2V	110.4V	
	RECOMMENDED BATTERY CAPACITY(AMP HOURS)(Note 2)	120 ~ 350AH	60 ~ 175AH	30 ~ 85AH	
	BATTERY TYPE	Open & Sealed Lead Acid			
	OUTPUT CURRENT	35A	17.5A	8.7A	
INPUT	VOLTAGE RANGE <small>Note 3</small>	90 ~ 305VAC 250 ~ 431VDC			
	FREQUENCY RANGE	47 ~ 63Hz			
	POWER FACTOR (Typ.)	PF>0.99/115VAC, PF>0.95/230VAC, PF>0.93/277VAC at full load			
	EFFICIENCY (Typ.)	95%	96%	96%	
	AC CURRENT (Typ.)	10.1A / 115VAC	5.3A / 230VAC	4.5A / 277VAC	
	INRUSH CURRENT(Typ.)	Cold start 40A at 230VAC			
	LEAKAGE CURRENT	<0.75mA / 240VAC			
PROTECTION	SHORT CIRCUIT	Constant current limiting, unit will shutdown after 5 sec, re-power on to recover.			
	OVER VOLTAGE	30 ~ 35V	60 ~ 70V	125 ~ 145V	
	OVER TEMPERATURE	Protection type :Shut down O/P voltage, recovers automatically after temperature goes down			
FUNCTION	REMOTE ON/OFF CONTROL	Power ON : Short circuit Power OFF : Open circuit			
	AUXILIARY POWER	12V @ 0.5A tolerance ±10%, ripple=150mVp-p			
	DC-OK SIGNAL	The TTL signal out, PSU turn on = 4.4 ~ 5.5V ; PSU turn off = -0.5 ~ 0.5V. Please refer to the Function Manual.			
ENVIRONMENT	WORKING TEMP.	-40 ~ +70°C (Refer to "Derating Curve")			
	WORKING HUMIDITY	20 ~ 95% RH non-condensing			
	STORAGE TEMP., HUMIDITY	-40 ~ +80°C, 10 ~ 95% RH non-condensing			
	TEMP. COEFFICIENT	±0.03%/°C (0 ~ 50°C)			
	VIBRATION	20 ~ 500Hz, 10G 12min./1cycle, period for 72min. each along X, Y, Z axes			
SAFETY & EMC (Note.4)	SAFETY STANDARDS	UL62368-1, TUV EN62368-1, EAC TP TC 004 approved; design refer to EN61558-1, EN60335-1(by request)			
	WITHSTAND VOLTAGE	I/P-O/P:3KVAC I/P-FG:2KVAC O/P-FG:1.25KVAC			
	ISOLATION RESISTANCE	I/P-O/P, I/P-FG, O/P-FG:100M Ohms/500VDC/25°C / 70%RH			
	EMC EMISSION	<b>Parameter</b>	<b>Standard</b>	<b>Test Level / Note</b>	
		Conducted	EN55032 (CISPR32)	Class B	
		Radiated	EN55032 (CISPR32)	Class A	
		Harmonic Current	EN61000-3-2	Class A	
		Voltage Flicker	EN61000-3-3	----	
	EMC IMMUNITY	EN55024 , EN61000-6-2			
		<b>Parameter</b>	<b>Standard</b>	<b>Test Level / Note</b>	
		ESD	EN61000-4-2	Level 3, 8KV air ; Level 2, 4KV contact	
		Radiated	EN61000-4-3	Level 3	
		EFT / Burst	EN61000-4-4	Level 3	
Surge		EN61000-6-2	2KV/Line-Line 4KV/Line-Earth		
Conducted		EN61000-4-6	Level 3		
Magnetic Field		EN61000-4-8	Level 4		
Voltage Dips and Interruptions	EN61000-4-11	>95% dip 0.5 periods, 30% dip 25 periods, >95% interruptions 250 periods			
OTHERS	MTBF	197.9K hrs min. Telcordia SR-332 (Bellcore) ; 52.32K hrs min. MIL-HDBK-217F (25°C)			
	DIMENSION	310*144*48.5mm (L*W*H)			
	PACKING	4Kg;4pcs/17Kg/1.04CUFT			
NOTE	<p>1. All parameters NOT specially mentioned are measured at 230VAC input, rated load and 25°C of ambient temperature.</p> <p>2. This is Mean Well's suggested range. Please consult your battery manufacturer for their suggestions about maximum charging current limitation.</p> <p>3. Derating may be needed under low input voltages. Please check the derating curve for more details.</p> <p>4. The power supply is considered a component which will be installed into a final equipment. All the EMC tests are been executed by mounting the unit on a 720mm*360mm metal plate with 1mm of thickness. The final equipment must be re-confirmed that it still meets EMC directives. For guidance on how to perform these EMC tests, please refer to "EMI testing of component power supplies." (as available on <a href="http://www.meanwell.com">http://www.meanwell.com</a>)</p> <p>5. The ambient temperature derating of 3.5°C/1000m with fanless models and of 5°C/1000m with fan models for operating altitude higher than 2000m(6500ft).</p> <p>※ Product Liability Disclaimer : For detailed information, please refer to <a href="https://www.meanwell.com/serviceDisclaimer.aspx">https://www.meanwell.com/serviceDisclaimer.aspx</a></p>				

### ■ BLOCK DIAGRAM

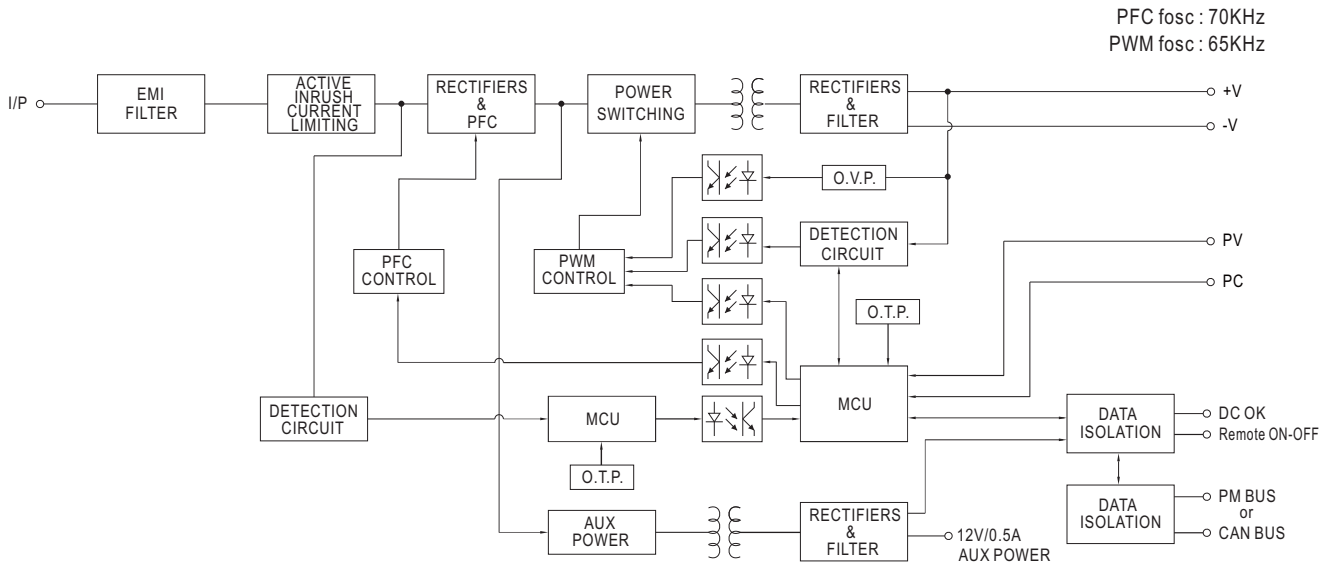

### ■ DERATING CURVE

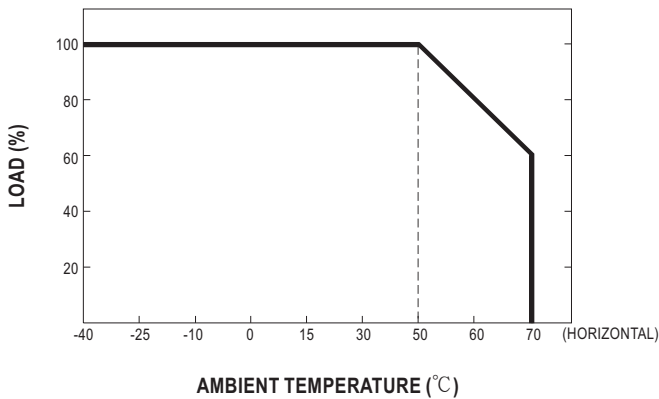

### ■ STATIC CHARACTERISTICS

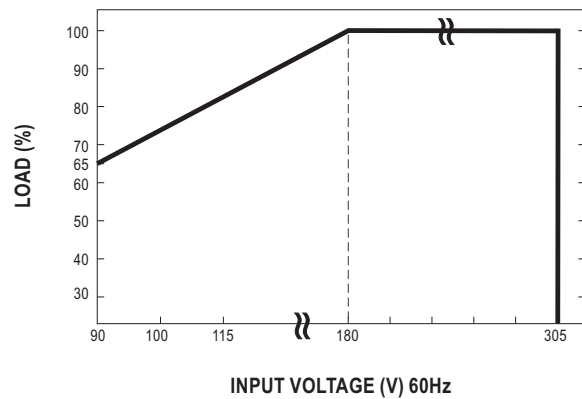

※ For 100V model charging mode, output current is 20% rated min. when operating temperature at -40°C, and can reach 100% above -30°C.

## FUNCTION MANUAL

### 1. Charging Curve

- ※ By default, the HEP-1000 operates in power supply mode, and it can be configured to charger mode by PMBus, CANBus, or SBP-001.
- ※ By factory default, this charger performs the default curve which can be programmed via PMBus and CANBus.
- ※ To accommodate the parameters of the charging curve, SBP-001, the smart battery charging programmer designed by MEAN WELL, and a personal computer are needed. Please contact MEAN WELL for details.

#### ※ Default 2 stage charging curve

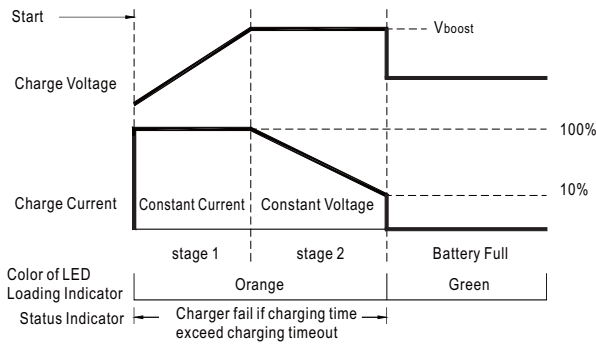

State	HEP-1000-24	HEP-1000-48	HEP-1000-100
Constant Current	35A	17.5A	8.7A
V <sub>boost</sub>	28.8V	57.6V	115.2V

◎ Suitable for lead-acid batteries (flooded, Gel and AGM) and Li-ion batteries (lithium iron and lithium manganese).

#### ※ Default 3 stage charging curve

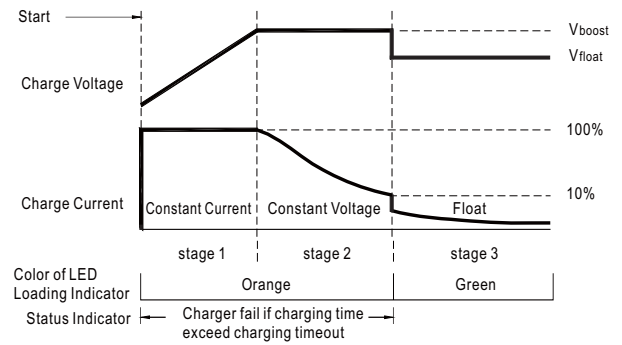

State	HEP-1000-24	HEP-1000-48	HEP-1000-100
Constant Current	35A	17.5A	8.7A
V <sub>boost</sub>	28.8V	57.6V	115.2V
V <sub>float</sub>	27.6V	55.2V	110.4V

◎ Suitable for lead-acid batteries (flooded, Gel and AGM) and Li-ion batteries (lithium iron and lithium manganese).

### 2. Front Panel LED Indicators & Corresponding Signal at Function Pins

LED	Description
● Green	Float (stage 3)
● Orange	Charging (stage 1 or stage 2)
● Red	Abnormal status (OTP, OLP, Charging timeout.)
● Red (Flashing)	The LED will flash with the red light when the internal temperature reaches 95°C; under this condition, the unit still operates normally without entering OTP. (In the meantime, an alarm signal will be sent out through the PMBus interface.)

### 3. Output Voltage Programming (or, PV / remote voltage programming / remote adjust / margin programming / dynamic voltage trim)

- ※ In addition to the adjustment via the built-in potentiometer, the output voltage can be trimmed by applying EXTERNAL VOLTAGE.

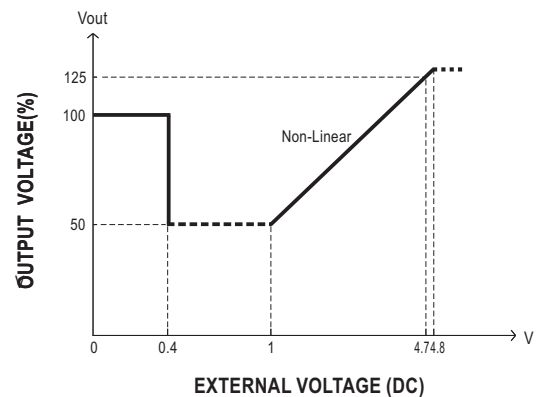
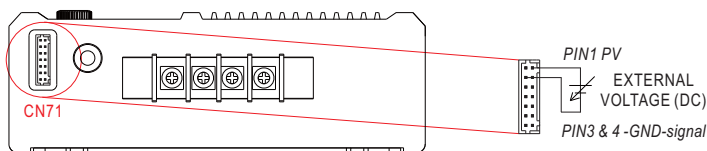

#### 4. Output Current Programming (or, PC / remote current programming / dynamic current trim)

※ The output current can be trimmed to 20~100% of the rated current by applying EXTERNAL VOLTAGE.

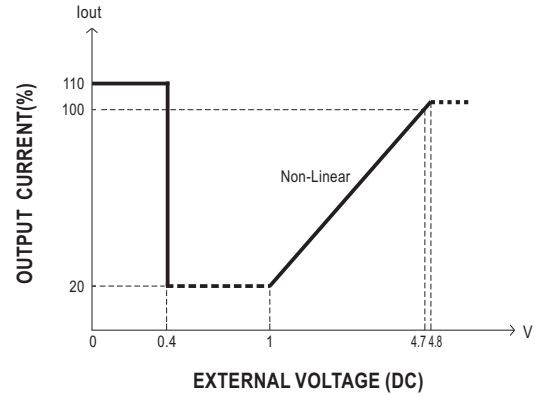
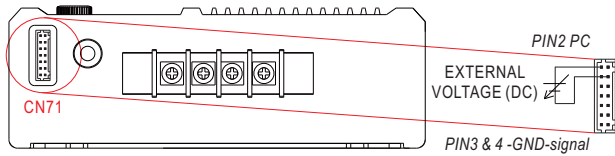

#### 5. Remote ON-OFF Control

The power supply can be turned ON/OFF individually or along with other units in parallel by using the "Remote ON-OFF" function.

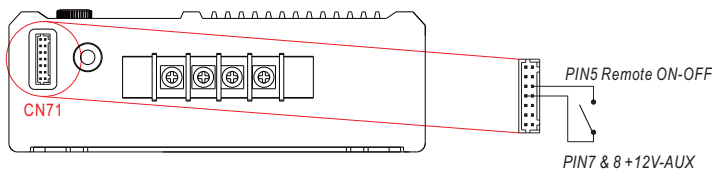

Remote ON-OFF	Power Supply Status
Short circuit	ON
Open circuit	OFF

#### 6. DC-OK Signal

DC-OK signal is a TTL level signal. The maximum source current is 10mA and the maximum external voltage is 5.5V.

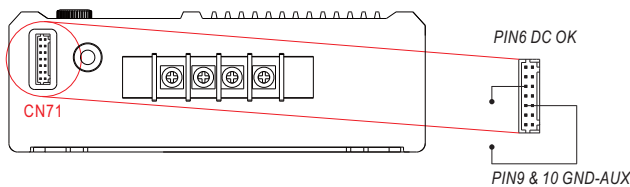

DC-OK signal	Power Supply Status
"High" >4.4~5.5V	ON
"Low" <-0.5~0.5V	OFF

#### 7. Temperature Compensation

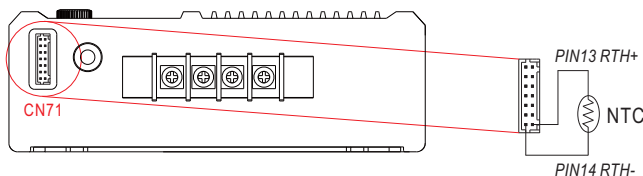

- ◎ To exploit the temperature compensation function, please attach the temperature sensor, NTC, which is enclosed with the charger, to the battery or the battery's vicinity.
- ◎ The charger is able to work normally without the NTC.

#### 8. PMBus Communication Interface

HEP-1000 supports PMBus Rev. 1.1 with maximum 100KHz bus speed, allowing information reading, status monitoring, output trimming, etc. For details, please refer to the User's Manual.

## MECHANICAL SPECIFICATION

Case No.228F

Unit:mm

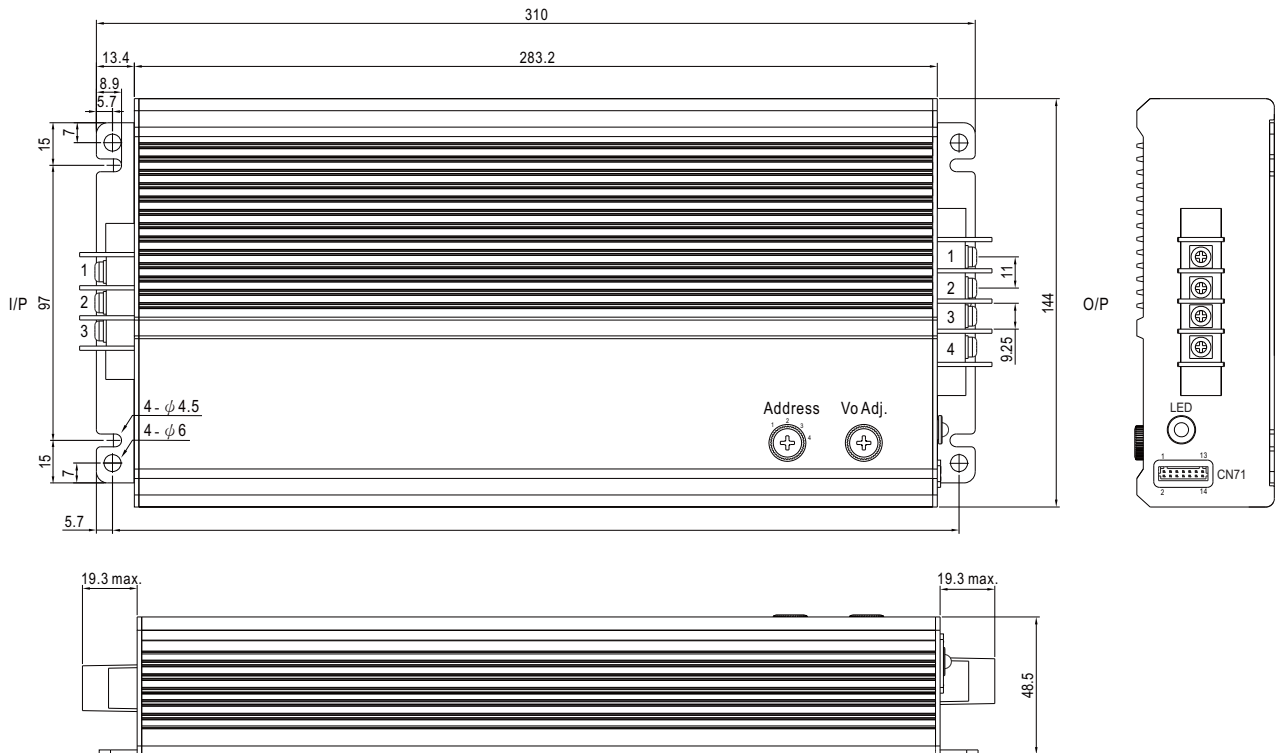

- ※ Output voltage current level can be adjusted through internal potentiometer.(Vo Adj.)  
(Can access by removing the rubber stopper on the case.)
- ※ PMBus interface address selection.(Address)

AC Input Terminal Pin No. Assignment

Pin No.	Assignment
1	FG (⊖)
2	AC/L
3	AC/N

DC Output Terminal Pin No. Assignment

Pin No.	Assignment
1,2	-V
3,4	+V

※Control Pin No. Assignment(CN71) : JST S14B-PHDKS-B or equivalent

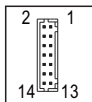

Mating Housing	JST PHDR-14VS or equivalent
Terminal	JST SPHD-001T-P0.5 or equivalent

Pin No.	Function	Description
1	PV	Connection for output voltage programming.(Note 1)
2	PC	Connection for constant current level programming.(Note.1)
3,4	GND (Signal)	Negative output voltage signal.
5	Remote ON-OFF	The unit can turn the output ON/OFF by dry contact between Remote ON/OFF and +12-AUX.(Note.2) Short (10.8 ~ 13.2V) : Power ON ; Open(0 ~ 0.5V) : Power OFF ; The maximum input voltage is 13.2V
6	DC-OK	Low (-0.5 ~ 0.5V) : When $V_{out} \leq 77\% \pm 6\%$ at power mode. $V_{out} \leq 66\% \pm 6\%$ at charger mode. High (4.4 ~ 5.5V) : When $V_{out} \geq 80\% \pm 6\%$ at power mode. $V_{out} \geq 67\% \pm 6\%$ at charger mode. The maximum sourcing current is 10mA and only for output.(Note.2)
7,8	+12V-AUX	Auxiliary voltage output, 10.8~13.2V, referenced to GND-AUX (pin9 & 10). The maximum load current is 0.5A. This output is not controlled by "Remote ON-OFF".
9,10	GND-AUX	Auxiliary voltage output GND. The signal return is isolated from the output terminals (+V & -V).
11	SDA	For PMBus model: Serial Data used in the PMBus interface. (Note.2)
	CANH	For CANBus model: Data line used in CANBus interface. (Note.2)
12	SCL	For PMBus model: Serial Clock used in the PMBus interface. (Note.2)
	CANL	For CANBus model: Data line used in CANBus interface. (Note.2)
13	RTH+	Temperature sensor(NTC, 5KOhm) comes along with the charger can be connected to the unit to allow temperature compensation of the charging voltage.
14	RTH-	

Note1: Non-isolated signal, referenced to [GND(signal)].

Note2: Isolated signal, referenced to GND-AUX.

## INSTALLATION MANUAL

Please refer to : <http://www.meanwell.com/manual.html>