



# Test Report: RST-5000-24

---

5000W Single Output Switching Power Supply

## ■ DESIGN VERIFY TEST

Output Function Test

Input Function Test

Protection Function Test

Control Function Test

Component Stress Test

## ■ SAFETY & E.M.C. TEST

Safety Test

E.M.C. Test

## ■ RELIABILITY TEST

ENVIRONMENT TEST

## DESIGN VERIFY TEST

### OUTPUT FUNCTION TEST

NO	TEST ITEM	SPECIFICATION	TEST CONDITION	RESULT
1	OUTPUT VOLTAGE ADJUST RANGE	CH1:23.5 V~28.8 V	I/P:230VAC(Δ) I/P:400VAC(Y) O/P:MIN. LOAD Ta:25°C	29.69V~22.98V /230VAC(Δ) 29.69V~22.98V/400VAC(Y)
2	OUTPUT VOLTAGE TOLERANCE	V1: -1%~ 1% (Max)	I/P: 196VAC /305VAC(Δ) I/P:340VAC /530VAC(Y) O/P:FULL/ MIN. LOAD Ta:25°C	V1:0 %~-0.26%(Δ) V1:0 %~-0.27%(Y)
3	LINE REGULATION	V1: -0.5%~ 0.5% (Max)	I/P: 196VAC~ 305VAC(Δ) I/P: 340VAC~ 530VAC(Y) O/P:FULL LOAD Ta:25°C	V1: 0 %~ 0%(Δ) V1:0 %~ 0%(Y)
4	LOAD REGULATION	V1: -0.5%~ 0.5% (Max)	I/P: 230VAC(Δ) I/P:400VAC(Y) O/P:FULL ~MIN LOAD Ta:25°C	V1:-0.02%~-0.25%(Δ) V1:-0.01 %~-0.25%(Y)
5	OVER/UNDERSHOOT TEST	< ±5%	I/P: 230VAC(Δ) I/P:400VAC(Y) O/P:FULL LOAD Ta:25°C	<1.25% /230VAC(Δ) <1.25% /400VAC(Y)
6	RIPPLE & NOISE	V1: 150mVp-p (Max)	I/P:230VAC(Δ) I/P:400VAC(Y) O/P:FULL LOAD Ta:25°C	V1: 147 mVp-p(Δ) V1: 146 mVp-p(Y)
		<p>INPUT=400VAC @ FULL LOAD</p> <div style="display: flex; justify-content: space-around;"> <div style="text-align: center;"> <p>high frequency :</p> </div> <div style="text-align: center;"> <p>low frequency :</p> </div> </div>		
7	SET UP TIME	230VAC/ 2200ms (Max) 400VAC/ 2200ms (Max)	I/P: 230VAC(Δ) I/P:400VAC(Y) O/P:FULL LOAD Ta:25°C	230VAC(Δ) /1810ms 400VAC (Y) /1820ms

	<p>INPUT=400VAC @ FULL LOAD CH1 : AC Input Voltage CH2 : Output Voltage</p> <p>Δ: 22.6 V @: 0.00 V Δ: 1.82 s @: -1.78 s</p>	<p>INPUT=230VAC @ FULL LOAD CH1 : AC Input Voltage CH2 : Output Voltage</p> <p>Δ: 20.4 V @: 20.5 V Δ: 1.81 s @: 28.0ms</p>	
<p>8 RISE TIME</p>	<p>230VAC/ 80ms (Max) 400VAC/ 80ms (Max)</p>	<p>I/P: 230VAC(Δ) I/P:400VAC(Y) O/P:FULL LOAD Ta:25°C</p>	<p>230VAC(Δ)/49.2 ms 400VAC(Y)/46ms</p>
	<p>INPUT=400VAC @ FULL LOAD CH2 : Output Voltage</p> <p>Δ: 19.3 V @: 21.6 V Δ: 46.0ms @: 34.0ms</p>		<p>INPUT=230VAC @ FULL LOAD CH2 : Output Voltage</p> <p>Δ: 21.0 V @: 2.40 V Δ: 49.2ms @: -14.4ms</p>
<p>9 HOLD UP TIME</p>	<p>230VAC/ 14ms (Typ.) 400VAC/ 14ms (Typ.)  230VAC/ 20ms (Typ.) 400VAC/ 20ms (Typ.)</p>	<p>I/P: 230VAC(Δ) FULL LOAD I/P:400VAC(Y) FULL LOAD  I/P: 230VAC(Δ) 75% LOAD I/P:400VAC(Y) 75% LOAD Ta:25°C</p>	<p>230VAC(Δ)/16.8ms 400VAC(Y)/16.4ms  230VAC(Δ)/27ms 400VAC(Y)/27ms</p>
	<p>INPUT=400VAC @ FULL LOAD CH1 : AC Input Voltage CH2 : Output Voltage</p> <p>Δ: 2.70 V @: 24.2 V Δ: 16.4ms @: -36.0ms</p>		<p>INPUT=230VAC @ FULL LOAD CH1 : AC Input Voltage CH2 : Output Voltage</p> <p>Δ: 2.60 V @: 21.6 V Δ: 16.8ms @: -35.2ms</p>
<p>10 DYNAMIC LOAD</p>	<p>V1:2400 mVp-p</p>	<p>I/P: 400VAC(Y) /230VAC(Δ) O/P: (1)FULL /50% LOAD 50%DUTY / 120HZ (2)FULL /50% LOAD 50%DUTY / 1KHZ</p>	<p>(1).1140 mVp-p @400VAC 1120 mVp-p @230VAC (2).950 mVp-p @400VAC 950 mVp-p @230VAC</p>

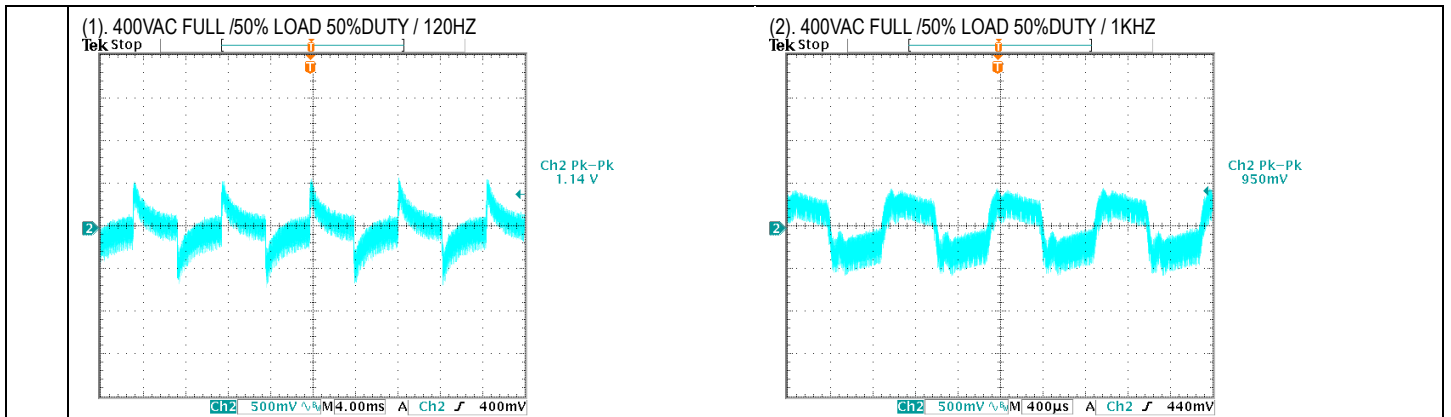

### INPUT FUNCTION TEST

NO	TEST ITEM	SPECIFICATION	TEST CONDITION	RESULT
1	INPUT VOLTAGE RANGE	3Phase 3 Wire 196VAC~305VAC 3Phase 4 Wire 340VAC~530VAC	I/P: TESTING O/P: FULL LOAD Ta: 25°C	193.9V~305 V(Δ) 330.8V~530V(Y)
			I/P: (1) LOW-LINE-3V=193(Δ) / 337V(Y) HIGH-LINE+5V=305(Δ) / 536V(Y) O/P: FULL/MIN LOAD ON: 30 Sec OFF: 30 Sec 10MIN (2) 230(Δ)/400Vac(Y) ON: 0.5 Sec OFF: 0.5 Sec 20MIN (3) 230(Δ)/400Vac(Y) ON: 3Sec OFF: 3Sec 12HOURS (AC POWER ON/OFF NO DAMAGE)	TEST: OK
2	INPUT FREQUENCY RANGE	47HZ ~63 HZ NO DAMAGE	I/P: 196 VAC ~305 VAC(Δ)/340~530VAC(Y) O/P: FULL-MIN LOAD Ta: 25°C	TEST: OK
3	INPUT CURRENT (Typ.)	230V (3Φ Δ) / 15A 400V (3Φ Y) / 9A	I/P: 230 VAC(Δ) I/P: 400VAC(Y) O/P: FULL LOAD Ta: 25°C	I = 13.78A / 230VAC(Δ) I = 8.007A / 400VAC(Y)
4	LEAKAGE CURRENT	<3.5mA / 305V (Δ)	I/P: 305VAC(Δ) O/P: NO LOAD Ta: 25°C	R-FG: 1.18mA S-FG: 1.18mA T-FG: 1.18mA R,S,T, -V(+): 0.8mA R,S,T-V(-): 0.8mA
5	POWER FACTOR (Typ.)	0.95 / 230VAC(Δ) 0.95 / 400VAC(Y)	I/P: 230 VAC(Δ) I/P: 400VAC(Y) O/P: FULL LOAD Ta: 25°C	PF=0.995 / 230VAC(Δ) PF=0.992 / 400VAC(Y)

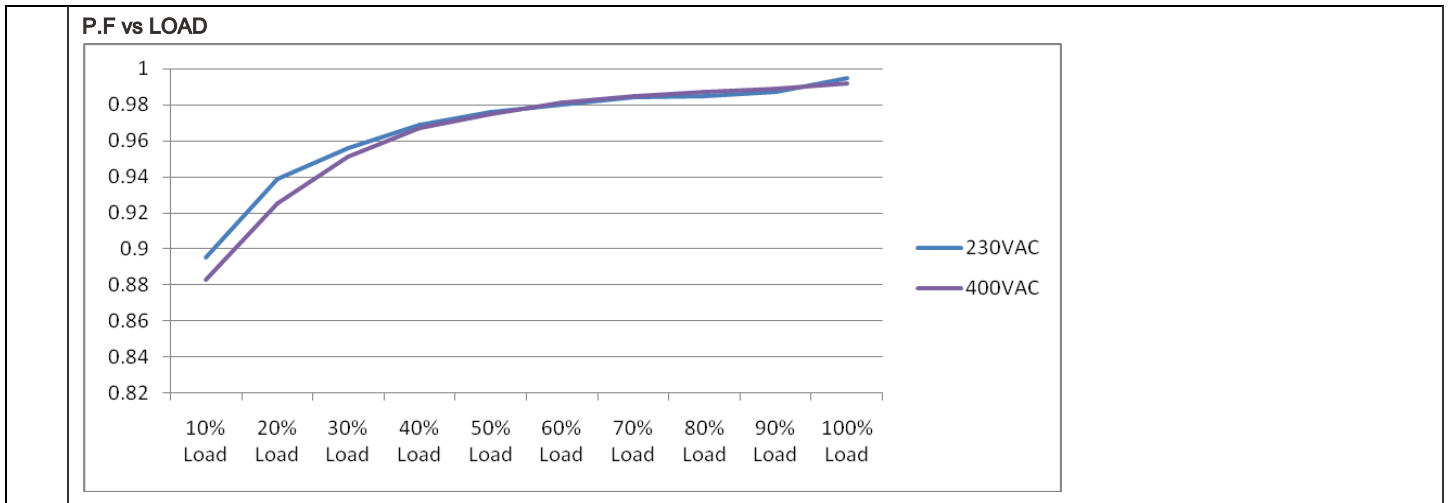

6	EFFICIENCY (Typ.)	89%	I/P:230 VAC(Δ) I/P:400VAC(Y) O/P:FULL LOAD Ta:25°C	89.04%/230VAC (Δ) 89.23%/400VAC(Y)
---	-------------------	-----	---	---------------------------------------

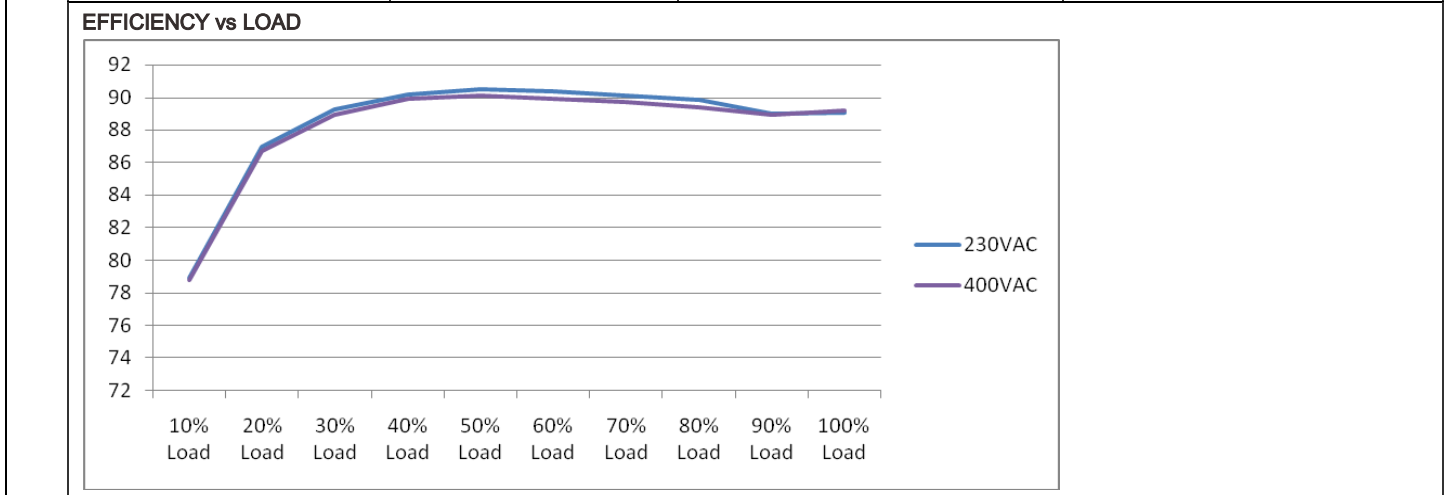

7	INRUSH CURRENT (Typ.)	230V/75A 400V/50A COLD START	I/P:230VAC(Δ) I/P:400VAC (Y) O/P:FULL LOAD Ta:25°C	I =59.5A/230VAC (Δ) I =49 A/ 400VAC (Y)
---	-----------------------	------------------------------------	---	--

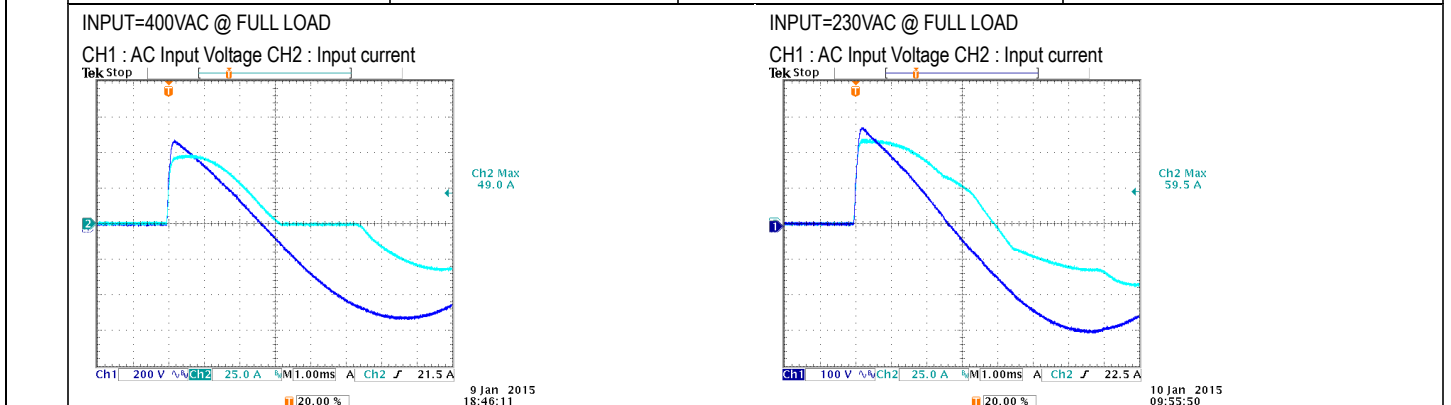

## PROTECTION FUNCTION TEST

NO	TEST ITEM	SPECIFICATION	TEST CONDITION	RESULT
1	OVER LOAD PROTECTION	100%~112%	I/P: 230VAC(Δ) I/P:400VAC(Y) O/P:TESTING Ta:25°C	104.67%/230VAC(Δ) 104.92%/400VAC(Y) User adjustable continuous constant current limiting or constant current limiting with delay shutdown after 5 seconds, re-power on to recover
2	OVER VOLTAGE PROTECTION	30V~33.6V	I/P: 230VAC/(Δ) I/P:400VAC(Y) O/P: MIN LOAD Ta:25°C	31.3V/ 230VAC(Δ) 31.3V/400VAC(Y) Shut down Re- power ON
3	OVER TEMPERATURE PROTECTION	Shut down o/p voltage · recovers automatically after temperature goes down	I/P: 230 VAC(Δ) I/P:400VAC(Y) O/P:FULL LOAD	Shut down o/p voltage · recovers automatically after temperature goes down
4	SHORT PROTECTION	SHORT EVERY OUTPUT 1 HOUR NO DAMAGE	I/P: 305VAC(Δ) I/P:530VAC(Y) O/P: FULL LOAD Ta:25°C	NO DAMAGE User adjustable continuous constant current limiting or constant current limiting with delay shutdown after 5 seconds, re-power on to recover

## CONTROL FUNCTION TEST

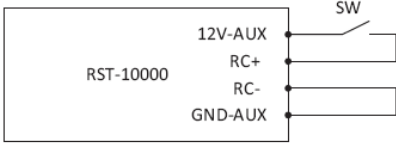
NO	TEST ITEM	SPECIFICATION	TEST CONDITION	RESULT						
1	AUXILIARY POWER (AUX)	12V@0.1A Only for Remote ON/OFF Control	I/P: 230 VAC(Δ) I/P: 400VAC(Y) O/P:FULL LOAD Ta:25°C	230 VAC(Δ): 11.874V /0.1 A 400VAC(Y): 11.874V /0.1 A						
2	Remote ON/OFF Control	<p>The PSU can be turned ON/OFF by using the "Remote ON/OFF" function.</p> <table border="1" style="width: 100%;"> <thead> <tr> <th>Between ON/OFF(CN313 or CN314 pin10) and 12V-AUX(CN315 pin1)</th> <th>Output Status</th> </tr> </thead> <tbody> <tr> <td>SW close (Short)</td> <td>PSU ON</td> </tr> <tr> <td>SW open (Open)</td> <td>PSU OFF</td> </tr> </tbody> </table> <div style="text-align: center;">  <p>Fig 1.1</p> </div> <p>I/P: 230 VAC(Δ) I/P: 400VAC(Y) O/P:FULL LOAD Ta:25°C</p>			Between ON/OFF(CN313 or CN314 pin10) and 12V-AUX(CN315 pin1)	Output Status	SW close (Short)	PSU ON	SW open (Open)	PSU OFF
Between ON/OFF(CN313 or CN314 pin10) and 12V-AUX(CN315 pin1)	Output Status									
SW close (Short)	PSU ON									
SW open (Open)	PSU OFF									
3	REMOTE SENSE	S+ / S- >0.3V	I/P: 400VAC(Y) O/P:FULL LOAD Ta:25°C	> 0.3 V						

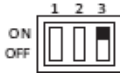
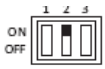
<p>4 OUTPUT VOLTAGE PROGRAMMABLE</p>	<p>I/P: 400VAC(Y)</p>  <p>DIP SW3 ON          CN313 PV+ Connect to external V+          CN313 PV- Connect to external V-</p> <table border="1"> <thead> <tr> <th>EXT.DC(V)</th> <th>Vout</th> <th>LOAD</th> </tr> </thead> <tbody> <tr><td>DC=1V±0.5%</td><td>20%±3%</td><td>0~100%</td></tr> <tr><td>DC=2V±0.5%</td><td>40%±3%</td><td>0~100%</td></tr> <tr><td>DC=3V±0.5%</td><td>60%±3%</td><td>0~100%</td></tr> <tr><td>DC=4V±0.5%</td><td>80%±3%</td><td>0~100%</td></tr> <tr><td>DC=5V±0.5%</td><td>100%±3%</td><td>0~100%</td></tr> <tr><td>DC=6V±0.5%</td><td>120%±3%</td><td>0~83.3%</td></tr> </tbody> </table>	EXT.DC(V)	Vout	LOAD	DC=1V±0.5%	20%±3%	0~100%	DC=2V±0.5%	40%±3%	0~100%	DC=3V±0.5%	60%±3%	0~100%	DC=4V±0.5%	80%±3%	0~100%	DC=5V±0.5%	100%±3%	0~100%	DC=6V±0.5%	120%±3%	0~83.3%	<table border="1"> <thead> <tr> <th>EXT.DC(V)</th> <th>Vout</th> <th>LOAD</th> </tr> </thead> <tbody> <tr><td>DC=1V</td><td>20.51%</td><td>0~100%</td></tr> <tr><td>DC=2V</td><td>40.37%</td><td>0~100%</td></tr> <tr><td>DC=3V</td><td>60.66%</td><td>0~100%</td></tr> <tr><td>DC=4V</td><td>80.87%</td><td>0~100%</td></tr> <tr><td>DC=5V</td><td>100.44%</td><td>0~100%</td></tr> <tr><td>DC=6V</td><td>119.78%</td><td>0~83.3%</td></tr> </tbody> </table>	EXT.DC(V)	Vout	LOAD	DC=1V	20.51%	0~100%	DC=2V	40.37%	0~100%	DC=3V	60.66%	0~100%	DC=4V	80.87%	0~100%	DC=5V	100.44%	0~100%	DC=6V	119.78%	0~83.3%
EXT.DC(V)	Vout	LOAD																																										
DC=1V±0.5%	20%±3%	0~100%																																										
DC=2V±0.5%	40%±3%	0~100%																																										
DC=3V±0.5%	60%±3%	0~100%																																										
DC=4V±0.5%	80%±3%	0~100%																																										
DC=5V±0.5%	100%±3%	0~100%																																										
DC=6V±0.5%	120%±3%	0~83.3%																																										
EXT.DC(V)	Vout	LOAD																																										
DC=1V	20.51%	0~100%																																										
DC=2V	40.37%	0~100%																																										
DC=3V	60.66%	0~100%																																										
DC=4V	80.87%	0~100%																																										
DC=5V	100.44%	0~100%																																										
DC=6V	119.78%	0~83.3%																																										
<p>5 OUTPUT CURRENT PROGRAMMABLE</p>	<p>I/P: 400VAC(Y)</p>  <p>DIP SW2 ON          CN313 PC+ Connect to external V+          CN313 PC- Connect to external V-</p> <table border="1"> <thead> <tr> <th>EXT.DC(V)</th> <th>Io_limit</th> <th>LOAD</th> </tr> </thead> <tbody> <tr><td>DC=1V±0.5%</td><td>20%±10%</td><td>0~100%</td></tr> <tr><td>DC=2V±0.5%</td><td>40%±10%</td><td>0~100%</td></tr> <tr><td>DC=3V±0.5%</td><td>60%±10%</td><td>0~100%</td></tr> <tr><td>DC=4V±0.5%</td><td>80%±10%</td><td>0~100%</td></tr> <tr><td>DC=5V±0.5%</td><td>100%±10%</td><td>0~100%</td></tr> </tbody> </table>	EXT.DC(V)	Io_limit	LOAD	DC=1V±0.5%	20%±10%	0~100%	DC=2V±0.5%	40%±10%	0~100%	DC=3V±0.5%	60%±10%	0~100%	DC=4V±0.5%	80%±10%	0~100%	DC=5V±0.5%	100%±10%	0~100%	<table border="1"> <thead> <tr> <th>EXT.DC(V)</th> <th>Ioout</th> <th>LOAD</th> </tr> </thead> <tbody> <tr><td>DC=1V</td><td>20.12%</td><td>0~100%</td></tr> <tr><td>DC=2V</td><td>41.00%</td><td>0~100%</td></tr> <tr><td>DC=3V</td><td>60.03%</td><td>0~100%</td></tr> <tr><td>DC=4V</td><td>80.18%</td><td>0~100%</td></tr> <tr><td>DC=5V</td><td>100.17%</td><td>0~100%</td></tr> </tbody> </table>	EXT.DC(V)	Ioout	LOAD	DC=1V	20.12%	0~100%	DC=2V	41.00%	0~100%	DC=3V	60.03%	0~100%	DC=4V	80.18%	0~100%	DC=5V	100.17%	0~100%						
EXT.DC(V)	Io_limit	LOAD																																										
DC=1V±0.5%	20%±10%	0~100%																																										
DC=2V±0.5%	40%±10%	0~100%																																										
DC=3V±0.5%	60%±10%	0~100%																																										
DC=4V±0.5%	80%±10%	0~100%																																										
DC=5V±0.5%	100%±10%	0~100%																																										
EXT.DC(V)	Ioout	LOAD																																										
DC=1V	20.12%	0~100%																																										
DC=2V	41.00%	0~100%																																										
DC=3V	60.03%	0~100%																																										
DC=4V	80.18%	0~100%																																										
DC=5V	100.17%	0~100%																																										
<p>6 Select OLP mode</p>	<p>I/P: 400VAC(Y)          O/P: FULL LOAD          Ta: 25°C</p> <table border="1"> <thead> <tr> <th>SW301</th> <th>PROTECTION</th> </tr> </thead> <tbody> <tr> <td>SW301 PIN1 ON</td> <td>Constant current delay 5sec Vo shutdown repower on</td> </tr> <tr> <td>SW301 PIN1 OFF</td> <td>Constant current</td> </tr> </tbody> </table>	SW301	PROTECTION	SW301 PIN1 ON	Constant current delay 5sec Vo shutdown repower on	SW301 PIN1 OFF	Constant current																																					
SW301	PROTECTION																																											
SW301 PIN1 ON	Constant current delay 5sec Vo shutdown repower on																																											
SW301 PIN1 OFF	Constant current																																											
<p>7 Front Panel Indicators</p>	<p>I/P: 400VAC(Y)          Ta: 25°C</p> <table border="1"> <thead> <tr> <th>LED</th> <th>Description</th> </tr> </thead> <tbody> <tr> <td>GREEN(LED1)</td> <td>LED on when output voltage is OK</td> </tr> <tr> <td>RED(LED2)</td> <td>LED on when any protection occurs</td> </tr> </tbody> </table>	LED	Description	GREEN(LED1)	LED on when output voltage is OK	RED(LED2)	LED on when any protection occurs																																					
LED	Description																																											
GREEN(LED1)	LED on when output voltage is OK																																											
RED(LED2)	LED on when any protection occurs																																											
<p>8 FAN LOCK TEST</p>	<p>I/P: 400VAC(Y)          O/P: FULL LOAD          Ta: 25°C</p> <p>Shut down Re-power ON</p>																																											
<p>9 AC- FAIL</p>	<p>I/P: 400VAC(Y)          O/P: FULL LOAD          Ta: 25°C</p> <table border="1"> <thead> <tr> <th>Test condition</th> <th>Input Voltage</th> <th>STATE</th> </tr> </thead> <tbody> <tr> <td>Low Line</td> <td>179±5Vac(Δ)</td> <td>AC Fail</td> </tr> <tr> <td>Low Line recovery</td> <td>192±5Vac(Δ)</td> <td>OK</td> </tr> </tbody> </table>	Test condition	Input Voltage	STATE	Low Line	179±5Vac(Δ)	AC Fail	Low Line recovery	192±5Vac(Δ)	OK																																		
Test condition	Input Voltage	STATE																																										
Low Line	179±5Vac(Δ)	AC Fail																																										
Low Line recovery	192±5Vac(Δ)	OK																																										
<p>10 CURRENT SHARING</p>	<p>&lt; ± 10%</p> <p>I/P: 400VAC(Y)          O/P : 90%/50% LOAD          Ta : 25°C</p> <p>O/P : 100%          PSU1 : 187.2 A          PSU2 : 177.6 A          PSU3 : 174.1 A</p> <p>O/P : 50%          PSU1 : 106 A          PSU2 : 99.8 A          PSU3 : 93.7 A</p>																																											

## 11 Alarm Signal Output

There are 4 alarm signals on CN315, and each signal can select two types of output circuit.

### (1) Relay contact output

Normally open contact. "Short" when the alarm arises. Relay contact rating(maximum) is 30V/1A resistive.

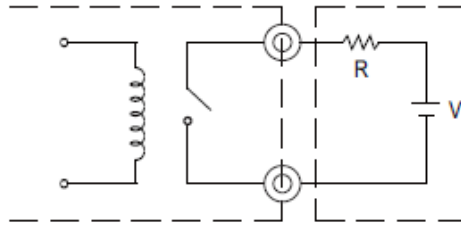

### (2) Open collector output

Normally open contact. "Short" when the alarm arises. Relay contact rating(maximum) is 30V/1A resistive.

An external voltage source is required for this function that is shown in Fig 7.2. These signals are isolated from output. The maximum sink current is

10mA and the maximum external voltage is 20V (there is a built-in 24V zener diode in inner circuitry).

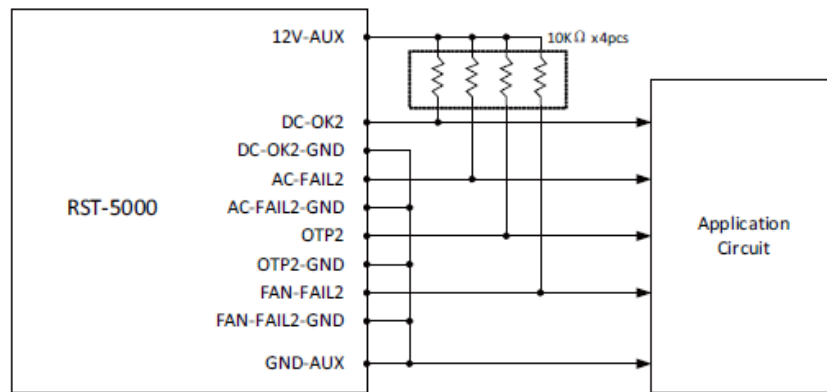

### TEST CONDITION :

I/P: 400VAC(Y)

O/P: FULL LOAD

Ta: 25°C

### RESULT:

Function	Description
DC- OK 1: AC-FAIL 1 FAN -FAIL 1 OTP 1	Alarm signal of AC-fail. Normally open contact. "Short" when the PSU input voltage is too low. Relay contact rating(maximum) is 30V/1A resistive.
DC- OK 2: AC-FAIL 2 FAN -FAIL 2 OTP 2	Alarm signal of AC fail. Open collector signal. Low when the PSU input voltage is too low. The maximum sink current is 10mA and the maximum external voltage is 20V.



## COMPONENT STRESS TEST

NO	TEST ITEM	SPECIFICATION	TEST CONDITION	RESULT
1	Power Transistor ( D to S) or (C to E) Peak Voltage	Q 124 Rated 500V/36A	I/P:High-Line +3V =308V(△) O/P: (1)Full Load input on/off (2)Output Short (3) Full load continue Ta : 25°C	(1)450V (2)444V (3)450V
2	Diode Peak Voltage	D452 Rated 300A/100V	I/P:High-Line +3V =308 V(△) O/P: (1)Full Load input on/off (2)Output Short (3)Full load continue Ta:25°C	(1)76.4V (2)62V (3)76.4V
3	Input Capacitor Voltage	C1 Rated: 470μ /450 V SURGE VOLTAGE:500V	I/P:High-Line +3V =308 V(△) O/P: (1)Full Load input on/off (2) Min load input on /Off (3) Full Load /Min load Change Ta:25°C	(1)460V (2)464V (3)448V
4	Control IC Voltage Test	U302 Rated 9.8V~18.5V	I/P : High-Line +3V = 308 V(△) O/P : (1)Full Load Turn on /Off (2) Min load Turn on /Off (3)Full Load /Min load Change Ta : 25°C	(1)12V (2)12V (3)12V
5	Power Transistor ( D to S) or (C to E) Peak Voltage	Q2 Rated 47A/ 600V	I/P : High-Line +3V = 308V(△) O/P : (1)Full Load Turn on (2) Output Short (3)Full load continue Ta : 25°C	(1)586V (2)437V (3)589V

■ SAFETY & E.M.C. TEST

**SAFETY TEST**

NO	TEST ITEM	SPECIFICATION	TEST CONDITION	RESULT
1	WITHSTAND VOLTAGE	I/P-O/P : 3 KVAC/min I/P-FG : 2KVAC/min O/P-FG : 0.5 KVAC/min	I/P-O/P : 3.6 KVAC/min I/P-FG : 2.4KVAC/min O/P-FG : 0.6 KVAC/min Ta : 25°C	I/P-O/P : 12.7 mA I/P-FG : 10.71 mA O/P-FG : 6.67 mA NO DAMAGE
2	ISOLATION RESISTANCE	I/P-O/P : 500VDC>100MΩ I/P-FG : 500VDC>100MΩ O/P-FG : 500VDC>100MΩ	I/P-O/P : 500 VDC I/P-FG : 500 VDC O/P-FG : 500 VDC Ta : 25°C /70%RH	I/P-O/P : 2.11 GΩ I/P-FG : 6.5 GΩ O/P-FG : 11.1 GΩ NO DAMAGE
3	GROUNDING CONTINUITY	FG(PE) TO CHASSIS OR TRACE < 100 mΩ	40 A /2min Ta : 25°C / 70%RH	18 mΩ

**E.M.C TEST**

NO	TEST ITEM	SPECIFICATION	TEST CONDITION	RESULT
1	HARMONIC	EN61000-3-2 CLASS A	I/P: 400VAC(50HZ) (Y) O/P:100%,LOAD Ta:25°C	PASS
2	CONDUCTION	EN55022 CLASS A	I/P: 400VAC(50HZ) (Y) O/P:FULL/50% LOAD Ta:25°C	Test by certified Lab
3	RADIATION	EN55022 CLASS A	I/P: 400VAC(50HZ) (Y) O/P:FULL LOAD Ta:25°C	Test by certified Lab
4	E.S.D	EN61000-4-2 INDUSTRY AIR:8KV / Contact:4KV	I/P: 400VAC(50HZ) (Y) O/P:FULL LOAD Ta:25°C	CRITERIA A
5	E.F.T	EN61000-4-4 INDUSTRY INPUT: 2KV	I/P: 400VAC(50HZ) (Y) O/P:FULL LOAD Ta:25°C	CRITERIA A
6	SURGE	IEC61000-4-5 INDUSTRY L-N :2KV L,N-PE:4KV	I/P: 400VAC(50HZ) (Y) O/P:FULL LOAD Ta:25°C	CRITERIA A
7	Test by certified Lab & Test Report Prepare			

■ RELIABILITY TEST

**ENVIRONMENT TEST**

NO	TEST ITEM	SPECIFICATION	TEST CONDITION	RESULT
1	TEMPERATURE RISE TEST	MODEL : RST-5000-24 1. ROOM AMBIENT BURN-IN : 2 HRS I/P : 230VAC(Δ) O/P : FULL LOAD Ta= 39 °C 2. HIGH AMBIENT BURN-IN : 2 HRS I/P : 230VAC(Δ) O/P : FULL LOAD Ta= 49.5 °C		
			ROOM AMBIENT Ta= 39 °C	HIGH AMBIENT Ta= 49.5 °C
NO	Position	ROOM AMBIENT Ta= 39 °C	HIGH AMBIENT Ta= 49.5 °C	
1	LF501	41.4°C	52.8°C	
2	L501	51.1°C	62.1°C	
3	LF502	44.1°C	55.9°C	
4	Q151	67.7°C	79.5°C	
5	Q126	68.2°C	78.6°C	
6	D3	80.1°C	88.2°C	
7	D43	73.9°C	81.3°C	
8	Q3	85.7°C	95.9°C	
9	Q43	78.6°C	90.1°C	
10	BD1	99.7°C	110.1°C	
11	BD41	95.2°C	107.8°C	
12	T453(CORE)	61.2°C	72.0°C	
13	L1	63.7°C	75.3°C	
14	C1	54.9°C	65.5°C	
15	T123	56.3°C	68.4°C	
16	L121	77.9°C	88.6°C	
17	D148	57.6°C	69.6°C	
18	U204	62.2°C	73.6°C	
19	D454	84.6°C	95.1°C	
20	RTH1	59.3°C	66.4°C	
21	T451	84.3°C	96.4°C	
22	T452	84.9°C	97.4°C	
23	T453	88.2°C	91.7°C	
24	D456	54.1°C	67.1°C	
25	L452	65.4°C	80.5°C	
26	C453	41.9°C	52.9°C	
27	C456	40.9°C	51.4°C	
28	U601	54.0°C	66.0°C	
29	U603	62.9°C	75.9°C	
30	T601	51.9°C	64.0°C	
31	T602	56.3°C	69.1°C	
32	Q640	46.5°C	59.4°C	
33	C647	48.8°C	60.5°C	
34	C602	49.0°C	61.2°C	
35	C621	53.2°C	65.0°C	
36	RG603	57.2°C	69.0°C	
37	U302	44.9°C	56.1°C	
38	U308	43.4°C	54.5°C	
39	C319	47.3°C	58.8°C	
40	C122	71.1°C	73.2°C	
41	C146	56.5°C	68.1°C	
42	TSW1	79.8°C	87.3°C	
43	C465	53.2°C	65.4°C	



2	OVER LOAD BURN-IN TEST	NO DAMAGE 1 HOUR ( MIN )	I/P : 230 VAC(Δ) O/P : 104 % LOAD Ta : 25°C	TEST : OK
3	LOW TEMPERATURE TURN ON TEST	TURN ON AFTER 2 HOUR	I/P : 305VAC/196VAC(Δ) O/P : 100 % LOAD Ta= -35 °C	TEST : OK
4	HIGH HUMIDITY HIGH TEMPERATURE HIGH VOLTAGE TURN ON TEST	AFTER 12 HOURS IN CHAMBER ON CONTROL 50 °C NO DAMAGE	I/P : 308 VAC(Δ) O/P : FULL LOAD Ta= 50 °C HUMIDITY= 95 %R.H	TEST : OK
5	TEMPERATURE COEFFICIENT	± 0.05 %(0~50°C)	I/P : 230 VAC(Δ) O/P : FULL LOAD	± 0.004 %(0~50°C)
6	STORAGE TEMPERATURE TEST	1. Thermal shock Temperature : -45°C~ +90°C 2. Temperature change rate : 25°C / MIN 3. Dwell time low and high temperature : 30 MIN/EACH 4. Total test cycle : 5 CYCLE 5. Input/Output condition : STATIC		OK
7	THERMAL SHOCK TEST	1. Thermal shock Temperature : -35°C~ +55°C 2. Temperature change rate : 25°C / MIN 3. Dwell time low and high temperature : 30 MIN/EACH 4. Total test cycle : 10 CYCLE 5. Input/Output condition : 230VAC(Δ)/Full Load		OK
8	VIBRATION TEST	1 Carton & 1 Set (1) Waveform : Sine Wave (2) Frequency : 10~500Hz (3) Sweep Time : 12min/sweep cycle (4) Acceleration : 2G (5) Test Time : 60min in each axis (X.Y.Z) (6) Ta : 25°C		TEST : OK
9	CAPACITOR LIFE CYCLE	SUPPOSE C453 IS THE MOST CRITICAL COMPONENT (1) I/P : 230VAC(Δ) O/P : FULL LOAD Ta= 25 °C LIFE TIME (2) I/P : 230VAC(Δ) O/P : FULL LOAD Ta= 50 °C LIFE TIME (3) I/P : 230VAC(Δ) O/P : 75% LOAD Ta= 50 °C LIFE TIME (4) I/P : 230VAC(Δ) O/P : 50% LOAD Ta= 50 °C LIFE TIME		(1) 2162895 HRS (2) 369297 HRS (3) 398634 HRS (4) 433136 HRS
10	MTBF	Conducted by Parts Stress Analysis Prediction 44.1K hrs min. Telcordia SR-332 (Bellcore) ; 34.6K hrs min. MIL-HDBK-217F (25°C)		OK
11	DMTBF/Accelerated Life Test	Demonstration Mean Time Between Failure (Expected Life): Above 50,000 hours @ TA 50°C		

TEST RESULT	TESTER	REVIEW	APPROVAL
PASS	DANIEL GAO	SANFORD SU	VINCENT ZENG

12.10.30 A50-F031